

# Pakon TreDo / StaLa

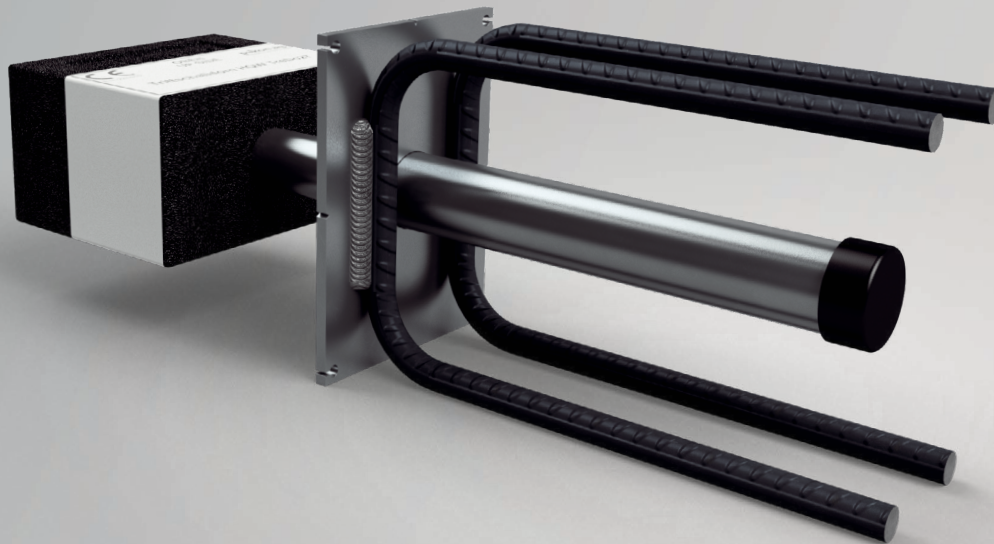

VB3-SZ-004-en-EU - 08/23 - PDF

European Technical Assessment (ETA-22/0910)

# Our products from the division BUILDING SOLUTIONS

## SERVICES

- » On-site tests -> we ensure that your requirements are properly covered by our planning.
- » Test reports -> for your safety and documentation.
- » Trainings -> the knowledge of your employees from planning and production is enhanced by our experts on site, online or via webinar.
- » Planning support -> latest design software, planning documents, CAD data and much more can be downloaded any time from [www.philipp-group.de](http://www.philipp-group.de).

## HIGH DEMANDS ON PRODUCT SAFETY AND PRACTICALITY

- » Close cooperation with notified bodies and - if necessary - approval of our solutions.

## TECHNICAL DEPARTMENT

- » Our expert-team will support you at any time during your planning phase with detailed advice.

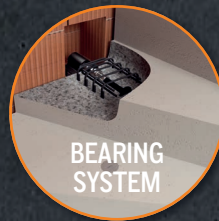
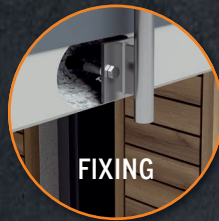
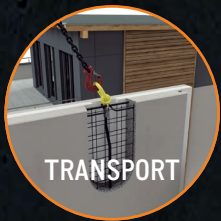



ETA-Danmark A/S  
Göteborg Plads 1 DK-  
2150 Nordhavn Tel.  
+45 72 24 59 00  
Fax +45 72 24 59 04  
Internet [www.etadanmark.dk](http://www.etadanmark.dk)

Authorised and notified according  
to Article 29 of the Regulation (EU)  
No 305/2011 of the European  
Parliament and of the Council of 9  
March 2011

MEMBER OF EOTA



## European Technical Assessment ETA-22/0910 of 2023/03/28

### I General Part

**Technical Assessment Body issuing the ETA and designated according to Article 29 of the Regulation (EU) No 305/2011: ETA-Danmark A/S**

**Trade name of the construction product:**

TreDo and StaLa Dowels

**Product family to which the above construction product belongs:**

Dowels for structural joints under static and quasi-static loading

**Manufacturer:**

Pakon AG  
Bahnhofstrasse 33  
CH 8867 Niederurnen  
Internet [www.pakonag.com](http://www.pakonag.com)

**Manufacturing plant:**

Pakon AG  
M 20 Areal, Wasterkingenweg  
CH 8193 Eglisau-Hüntwangen

**This European Technical Assessment contains:**

24 pages including 18 annexes which form an integral part of the document

**This European Technical Assessment is issued in accordance with Regulation (EU) No 305/2011, on the basis of:**

EAD 050019-00-0301, Dowels for structural joints under static and quasi-static loading

**This version replaces:**

Translations of this European Technical Assessment in other languages shall fully correspond to the original issued document and should be identified as such.

Communication of this European Technical Assessment, including transmission by electronic means, shall be in full. However, partial reproduction may be made, with the written consent of the issuing Technical Assessment Body. Any partial reproduction has to be identified as such.

## II SPECIFIC PART OF THE EUROPEAN TECHNICAL ASSESSMENT

### 1 Technical description of the product

**TreDo** is a dowel system for structural joints between structural concrete elements, which is made up of a sound insulation box at one side and the dowel type DB-N at the other side of the structural joint. The dowel type DB-N consists of a circular steel sleeve and ancillary steel reinforcement welded on the backside of a rigid steel anchor plate. The sound insulation box is available in several design variants with regard to the support structure inside. For the “TreDo” version the circular steel bar is welded on a load distributing steel plate with an elastomeric bearing underneath. For the “TreDo Duo” version, the circular steel bar is welded between two load distributing steel plates, each with an elastomeric bearing underneath or respectively above. A load transfer is possible in vertical direction both up and down. Both variants are also available as twin versions with two separate elastomeric bearings, called “TreDo Twin” and “TreDo Twin Duo”. For the “TreDo Duo+” version two additional steel plates with elastomeric bearings are attached laterally, so this version enables a load transfer in both vertical and horizontal directions. The support structures are surrounded by non-load bearing sound insulating material, all in all called sound insulation box. Furtheron there is the “TreDo ST” version with the steel bar resting on a vertical screw with height adjustment.

The TreDo steel bars are made of stainless steel or galvanized steel and the sleeves are made of stainless steel. Bars made of galvanized steel will be subjected to dry internal environment whereas bars and sleeves made of stainless steel can be subjected to environmental conditions acc. to EN 1993-1-4, Annex A depending on the corrosion resistance class.

The dowel system TreDo transmits shear forces across an expansion joint between structural concrete elements and rigid supports made of reinforced normal weight concrete of strength class C20/25 to C50/60 according to EN 206. The rigid support for the sound insulation box can also be a masonry wall with a concrete layer if necessary, whereas the bearing compressions at the masonry wall have to be designed acc. to EN 1996-1-1. The concrete elements are subjected to static and quasi-static actions only and they must have a minimum slab thickness of 150 mm. Further the concrete elements are subjected to fire exposure and designed acc. to EN 1992-1-1 and EN 1992-1-2.

TreDo belongs to the dowel family with a single bar and a sleeve with anchor plate and ancillary reinforcement. The dowel system allows axial movements only which take place at the circular sleeve.

**StaLa** is a dowel system for structural joints between a concrete member and a fixed point. StaLa uses the dowel types ESD-N and DB-N which consist of a circular dowel bar and a circular sleeve into which the bar is inserted at one side. At the other side a steel strap is welded to the head of the circular dowel bar and fixed mechanically to another concrete element or rigid member.

The StaLa steel bars are made of stainless steel, galvanized or normal steel and the sleeves are made of stainless steel or plastic. Bars made of galvanized or normal steel will be subjected to dry internal environment whereas bars and sleeves made of stainless steel or sleeves made of plastic can be subjected to environmental conditions acc. to EN 1993-1-4, Annex A depending on the corrosion resistance class.

The dowel system StaLa transmits shear loads across an expansion joint between a structural concrete element made of reinforced normal weight concrete of strength class C20/25 to C50/60 according to EN 206 and another rigid members. The concrete element and the rigid member are subjected to static and quasi-static actions only and the concrete elements must have a minimum slab thickness of 150 mm. Further the concrete element is subjected to fire exposure and designed acc. to EN 1992-1-1 and EN 1992-1-2.

StaLa belongs to the dowel family with a single bar and a sleeve with or without anchor plate and ancillary reinforcement. The dowel system allows axial movements only which take place at the circular sleeve. The fastening of the steel strap at a rigid member is supposed to be a fixed single bearing.

See further descriptions in Annex A.

## 2 Specification of the intended use in accordance with the applicable EAD 330046-01-0602

The TreDo dowel system transmits shear loads across an expansion joint between a structural concrete element made of reinforced normal weight concrete of strength classes C20/25 to C50/60 according to EN 206 and another rigid support. This rigid support, where the sound insulation box is placed on, can be a concrete or masonry wall with a concrete layer if necessary.

The concrete element and the rigid supports are subjected to static and quasi-static actions only. They are subjected to fire exposure and have to be designed acc. to EN 1992-1-1 and EN 1992-1-2. The minimum concrete slab thickness is equal to  $h_{\text{slab}} = \max(6 \cdot d_{\text{bar}}; 150 \text{ mm})$ .

The TreDo dowel system uses the DB-N dowel type allowing axial movements only which take place at the circular sleeve.

Bars and load distribution steel plates made of galvanized steel will be subjected to dry internal environment. Bars, load distribution steel plates, anchor plates and sleeves made of stainless steel can be subjected to environmental conditions acc. to EN 1993-1-4, Annex A depending on the corrosion resistance class.

The StaLa dowel system also transmits shear loads across an expansion joint between a structural concrete element made of reinforced normal weight concrete of strength classes C20/25 to C50/60 according to EN 206 and another rigid member.

The concrete elements and the rigid members are subjected to static and quasi-static actions only. They are subjected to fire exposure and have to be designed acc. to EN 1992-1-1 and EN 1992-1-2. The minimum concrete slab thickness is equal to  $h_{\text{slab}} = \max(6 \cdot d_{\text{bar}}; 150 \text{ mm})$ .

The StaLa dowel system uses the ESD-N or DB-N dowel types allowing axial movements only which take place at the circular sleeves.

Bars, sleeves, anchor plates and steel straps made of galvanized or normal steel will be subjected to dry internal environment. Bars, steel straps, anchor plates and sleeves made of stainless steel or plastic can be subjected to environmental conditions acc. to EN 1993-1-4, Annex A depending on the corrosion resistance class.

The performances given in Section 3 are only valid if the products are used in compliance with the specifications and conditions given in Annex A.

The provisions made in this European Technical Assessment are based on an assumed intended working life of the product of 50 years.

The indications given on the intended working life cannot be interpreted as a guarantee given by the producer or the Technical Assessment Body, but are to be regarded only as a means for selecting the appropriate products in relation to the expected economically reasonable working life of the works.

The real working life might be, in normal use conditions, considerably longer without major degradation affecting the basic requirements for construction works.

### 3 Performance of the product and references to the methods used for its assessment

Performances of the dowel systems, related to the basic requirements for construction works (hereinafter BWR), were determined according to EAD 050019-00-0301.

These performances, given in the following paragraphs, are valid as long as the components are the ones described in Annex A of this ETA.

Characteristic	Assessment of characteristic
<b>3.1 Mechanical resistance and stability (BWR 1)</b>	
Resistance to steel failure at ULS for TreDo with DB-N and StaLa with DB-N	$e = 0$ See Annex B1 to B2
Resistance to steel failure at ULS for StaLa with ESD-N	$e = 0.5 \cdot d_{\text{bar}}$ See Annex B3 to B4
Resistance to concrete edge failure at ULS for TreDo with DB-N and StaLa with DB-N	$X_{1,1} = 0.37$
	$B_{\text{spec},1}$ acc. to Annex B7
	$H_{\text{spec},1}$ acc. to Annex B7
Resistance to concrete edge failure at ULS for StaLa with ESD-N	$k_{1,1} = 0.5$
	$X_{1,1} = 0.60$
	$B_{\text{spec},1} = 0$
Resistance to concrete edge failure at SLS for TreDo and StaLa with DB-N	$H_{\text{spec},1} = c_1$ acc. to Annex B7
	$k_{1,1} = 0.5$
Resistance to concrete edge failure at SLS for TreDo and StaLa with DB-N	$X_2 = 0.57$
Resistance to concrete edge failure at SLS for StaLa with ESD-N	$X_2 = 0.41$
<b>3.2 Safety in case of fire (BWR2)</b>	
Reaction to fire	The dowels are made from steel classified as Euroclass A1 in accordance with EN 13501-1 and Commission Delegated Regulation 2016/364
Resistance to fire	See Annex C1

## 4 Attestation and verification of constancy of performance (AVCP)

### 4.1 AVCP system

According to the decision 1998/214/EC of the European Commission 1, as amended by 2003/639/EC, the system of assessment and verification of constancy of performance (see Annex V to Regulation (EU) No 305/2011) is:

2+

## 5 Technical details necessary for the implementation of the AVCP system, as foreseen in the applicable EAD

Technical details necessary for the implementation of the AVCP system are laid down in the control plan deposited at ETA-Danmark prior to CE marking.

Issued in Copenhagen on  
2023-03-28 by

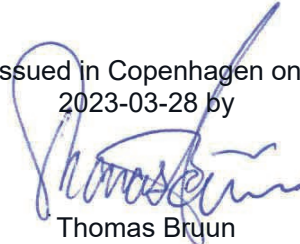

Thomas Bruun  
Managing Director, ETA-Danmark



TreDo with DB-N

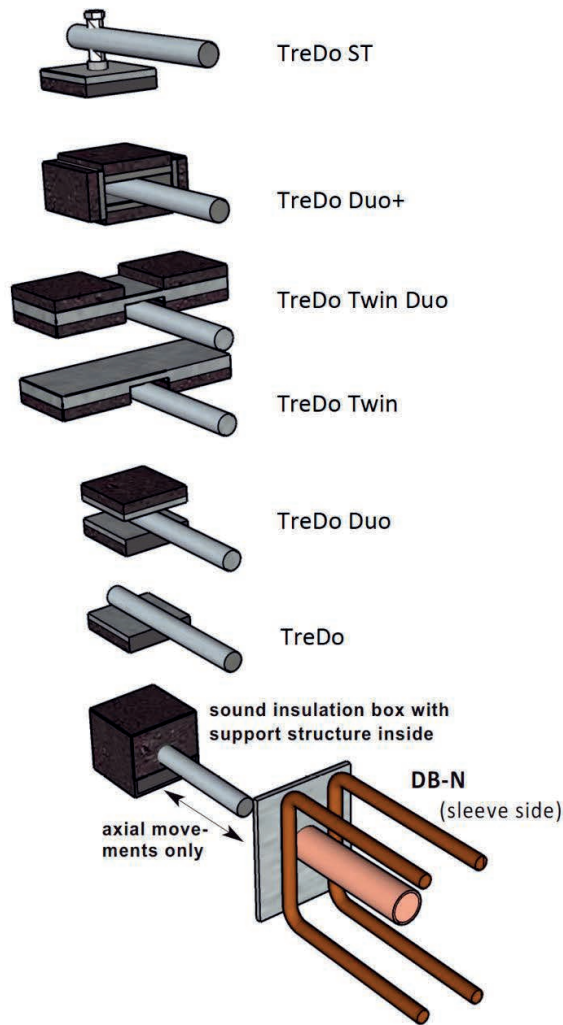

for the end connection of flight of stairs with stair landings or landing slabs

for the lateral connection of flight of winding stairs with staircase walls

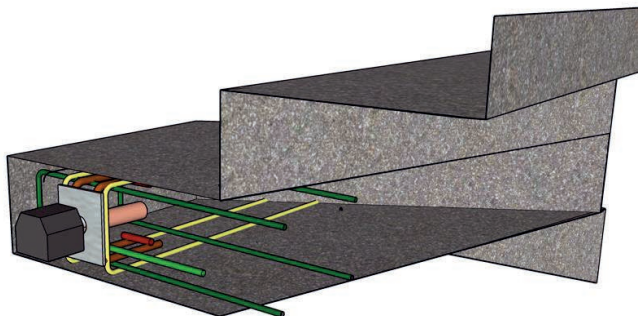
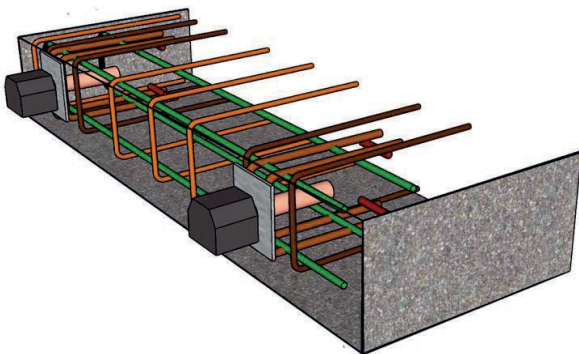

TreDo Dowels – Design Variants and Intended Use

Product description

Annex A1

## TreDo with DB-N – Geometrical Parameters

### TreDo components

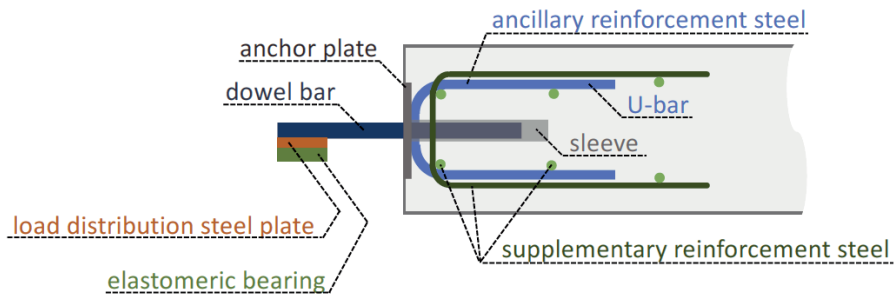

### Section

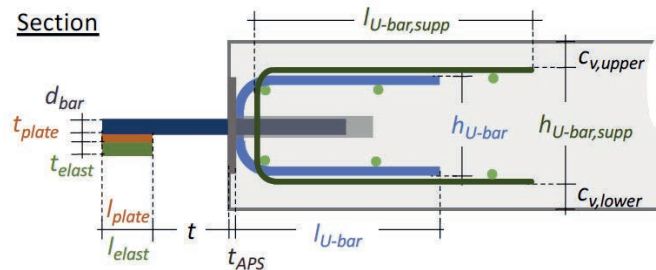

### Top view

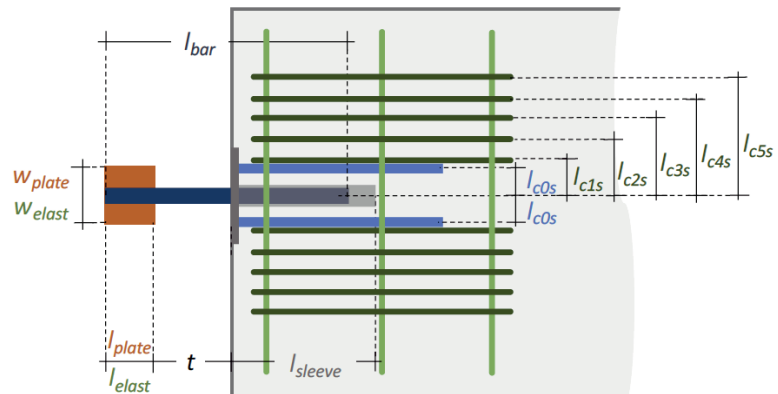

### Front view

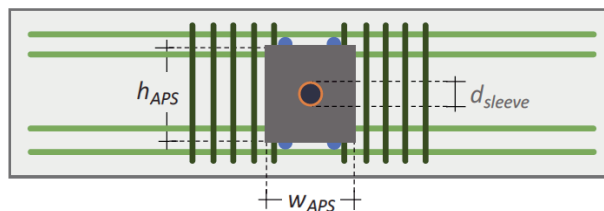

## TreDo Dowels – Geometrical Parameters with DB-N

Product description

Annex A2

TreDo Components		Dimensions	Material and Grades
DB-N	Bar	$d_{\text{bar}} = 27 \text{ mm}, 30 \text{ mm}, 33 \text{ mm}, 35 \text{ mm}, 40 \text{ mm};$ $l_{\text{bar}} = 5 \cdot d_{\text{bar}} + \text{up to } 90 \text{ mm} + l_{\text{plate}}$ for joint widths 10-90 mm	Galvanized steel 1.7225, 1.7227 or stainless steel 1.4571, 1.4482, 1.4462, 1.4404, 1.4362 or 1.4301; all $R_{p0,2} \geq 460 \text{ N/mm}^2$
	Anchor plate <sup>*1)</sup>	$w_{\text{APS}} = 65 \text{ mm up to } 200 \text{ mm}$ $h_{\text{APS}} = 85 \text{ mm up to } 210 \text{ mm}$ $t_{\text{APS}} = 4 \text{ mm up to } 10 \text{ mm}$	Stainless steel 1.4571, 1.4482, 1.4462, 1.4404, 1.4307 or 1.4301; all $R_{p0,2} \geq 235 \text{ N/mm}^2$
	Ancillary reinforcement steel <sup>*2)</sup> (welded on the anchor plate)	2 x 1 U-bar: $\varnothing 12 \text{ mm}, \varnothing 14 \text{ mm}, \varnothing 16 \text{ mm or } \varnothing 20 \text{ mm}$ $l_{\text{U-bar}} \approx 0,3 \cdot \alpha_1 \cdot \alpha_4 \cdot l_{b,\text{reqd}} + 3 \varnothing_{\text{U-bar}}^{\text{*4)}$ $h_{\text{U-bar}} \approx 5 \cdot d_{\text{bar}}$	B 500 A/B NR, B 500 A/B or B 550 A/B up to $\varnothing 20 \text{ mm};$ Stainless steel 1.4571, 1.4482, 1.4462, 1.4404, 1.4362, 1.4301 up to $\varnothing 20 \text{ mm};$ all $R_{p0,2} \geq 450 \text{ N/mm}^2$
	Supplementary reinforcement steel	2 x 1 up to 2 x 5 U-bars: $\varnothing 12 \text{ mm}, \varnothing 14 \text{ mm}, \varnothing 16 \text{ mm}, \varnothing 20 \text{ mm}, \varnothing 25 \text{ mm or } \varnothing 26 \text{ mm}$ $l_{\text{U-bar,supp}} \approx 0,6 \cdot \alpha_1 \cdot \alpha_4 \cdot l_{b,\text{reqd}} + 3 \varnothing_{\text{U-bar,supp}}^{\text{*4)}$ $h_{\text{U-bar,supp}} = h_{\text{slab}} - c_{v,\text{upper}} - c_{v,\text{lower}}$	B 500 A/B or B 550 A/B
	Sleeve (circular)	$d_{\text{sleeve,in}} = d_{\text{bar}} + 1 \text{ mm}, t_{\text{sleeve}} \geq 1,5 \text{ mm}$ $l_{\text{sleeve}} = 5 \cdot d_{\text{bar}} + \text{up to } 95 \text{ mm}$	Stainless steel acc. to EN 1993-1-4 [5], $R_{p0,2} \geq 235 \text{ N/mm}^2$
Sound insulation box <sup>*3)</sup>	Load distribution steel plates	Steel plates for TreDo, TreDo ST and TreDo DUO: $w_{\text{plate}} = 70 \text{ mm up to } 180 \text{ mm}$ $l_{\text{plate}} = 70 \text{ mm up to } 100 \text{ mm}$ $t_{\text{plate}} \geq 5 \text{ mm}$ Steel plates laterally for TreDo DUO+: $w_{\text{plate}} = 50 \text{ mm up to } 70 \text{ mm}$ $l_{\text{plate}} = 70 \text{ mm up to } 100 \text{ mm}$ $t_{\text{plate}} \geq 5 \text{ mm}$	Galvanized steel, stainless steel or normal steel; $R_{p0,2} \geq 235 \text{ N/mm}^2$
	Elastomeric bearings	$w_{\text{elast}} = 50 \text{ mm up to } 180 \text{ mm}$ $l_{\text{elast}} = 70 \text{ mm up to } 100 \text{ mm}$ $t_{\text{elast}} \geq 10 \text{ mm}$	EPDM or PUR
<p>*1) The height and width of the anchor plate can be increased slightly to meet the required thickness of concrete cover for the ancillary reinforcement steel.</p> <p>*2) A normal reinforcing steel B 500 A/B can be used, if the thickness of the concrete cover in accordance with EN 1992-1-1 is fulfilled, which can be controlled, for example, by the dimensions of the anchor plate.</p> <p>*3) The sound insulation box with its support structures inside has to be designed following the Eurocodes and/or general type approvals</p> <p>*4) The coefficient <math>\alpha_1</math> is set to 1.0 for straight legs of the supplementary reinforcement U-bars. The coefficient <math>\alpha_1</math> is set to 0.7 for standard bends, standard hooks or standard loops at the end of the supplementary reinforcement U-bars.</p> <p>The coefficient <math>\alpha_4</math> is usually set to 1.0. If there is a confinement by a transverse reinforcement bar with <math>\varnothing_t \geq 0.6 \cdot \varnothing_{\text{U-bar,supp}}</math> welded to each leg of the supplementary reinforcement U-bars, the coefficient <math>\alpha_4</math> can be set to 0.7.</p> <p>For the calculation of <math>l_{b,\text{reqd}}</math> the coefficient <math>\alpha_{ct}</math> is set to 1.0.</p>			
<b>TreDo Dowels – Components with Dimensions, Materials and Grades</b>			<b>Annex A3</b>
Product description			

StaLa with DB-N

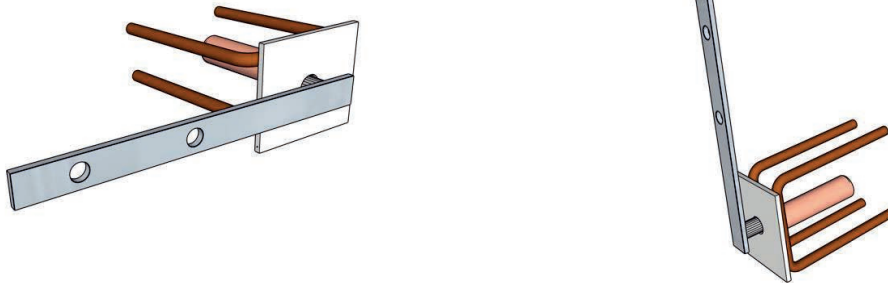

StaLa with ESD-N

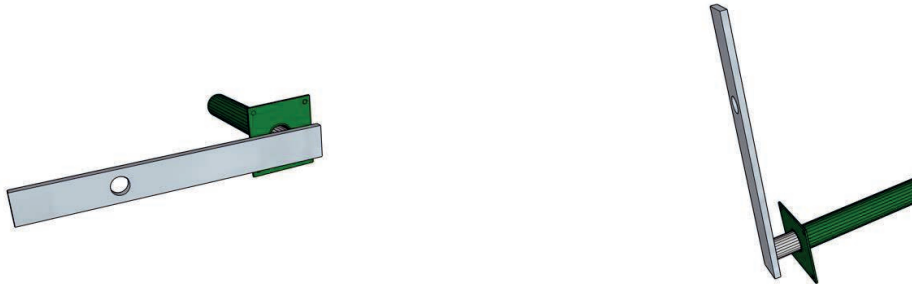

for the connection to a concrete element by a steel strap

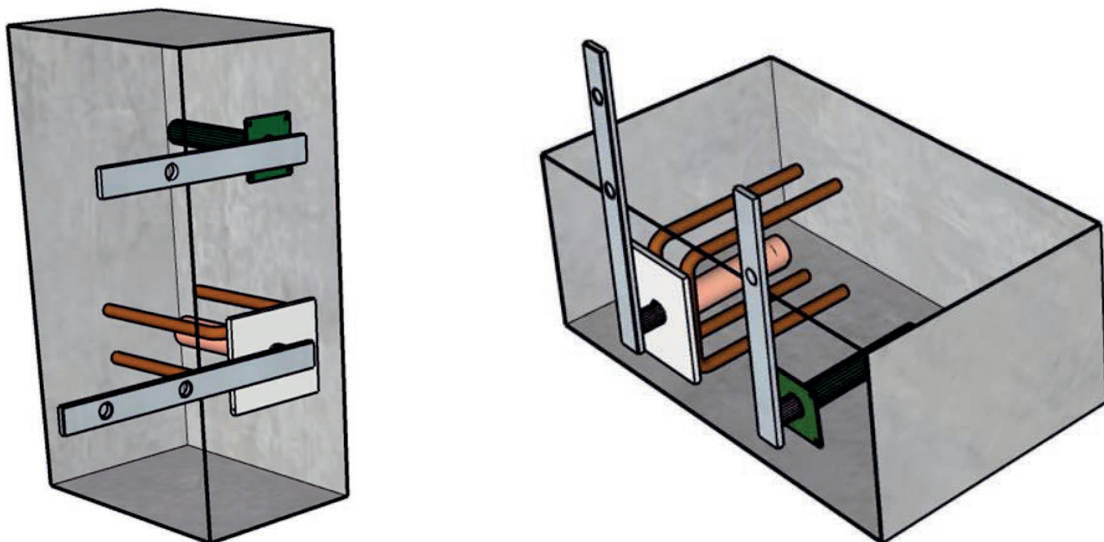

**StaLa Dowels – Design Variants and Intended Use**

Product description

**Annex A4**

StaLa with ESD-N – Geometrical Parameters

StaLa components

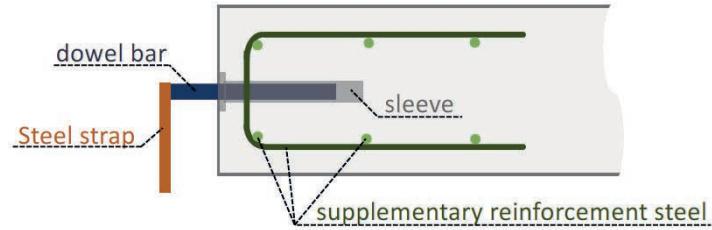

Section

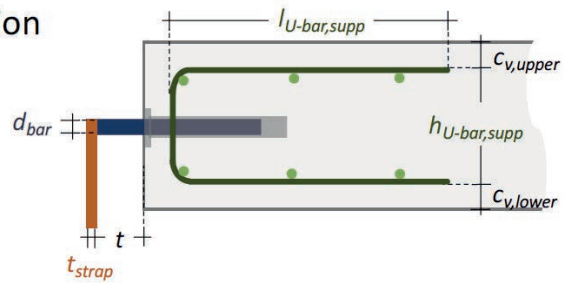

Top view

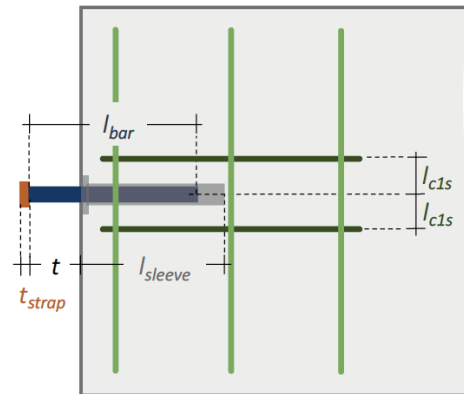

Front view

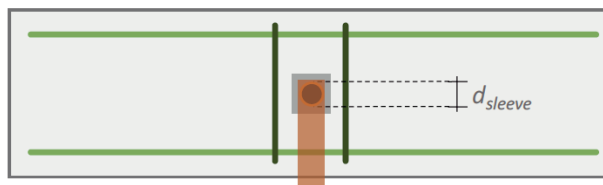

StaLa Dowels – Geometrical Parameters with ESD-N

Product description

Annex A5

## StaLa with DB-N – Geometrical Parameters

### StaLa components

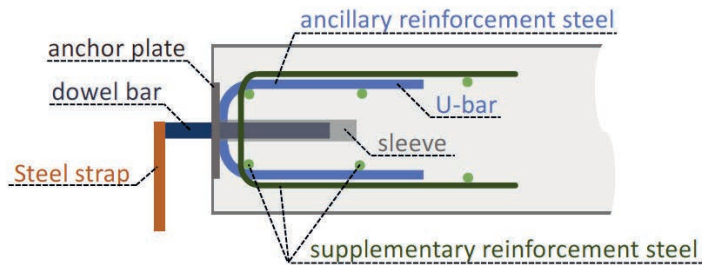

### Section

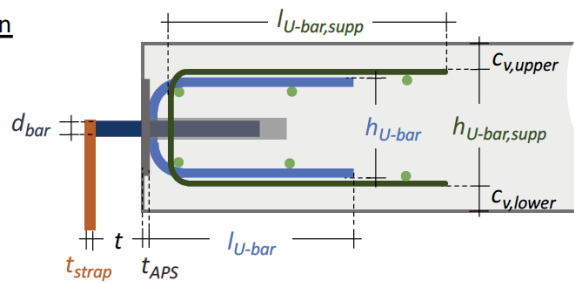

### Top view

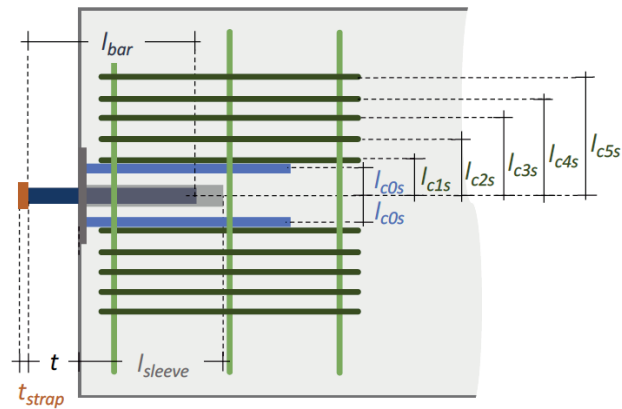

### Front view

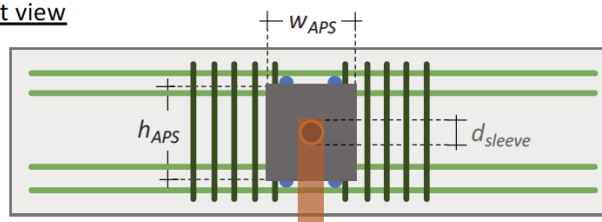

## StaLa Dowels – Geometrical Parameters with DB-N

Product description

Annex A6

StaLa Components		Dimensions	Material and Grades
ESD-N	Bar	$d_{\text{bar}} = 16 \text{ mm}, 20 \text{ mm}, 22 \text{ mm}, 24 \text{ mm}, 25 \text{ mm}, 27 \text{ mm}, 30 \text{ mm}, 35 \text{ mm};$ $l_{\text{bar}} = 5 \cdot d_{\text{bar}} + \text{up to } 60 \text{ mm for joint widths } 10\text{-}60 \text{ mm}$	Galvanized steel 1.7225, 1.7227 or stainless steel 1.4571, 1.4482, 1.4462, 1.4404, 1.4362 1.4301 or normal steel; all $R_{p0,2} \geq 235 \text{ N/mm}^2$
	Supplementary reinforcement steel	$2 \times 1 \text{ U-bar: } \varnothing 6 \text{ mm}, \varnothing 8 \text{ mm}, \varnothing 10 \text{ mm}, \varnothing 12 \text{ mm}, \varnothing 14 \text{ mm}, \varnothing 16 \text{ mm}, \varnothing 20 \text{ mm}$ $l_{\text{U-bar,supp}} = 0,6 \cdot \alpha_1 \cdot \alpha_4 \cdot l_{\text{b,rqd}} + 3 \varnothing_{\text{U-bar,supp}}^{*4)}$ $h_{\text{U-bar,supp}} = h_{\text{slab}} - c_{\text{v,upper}} - c_{\text{v,lower}}$	B 500 A/B or B 550 A/B
	Sleeve (circular)	$d_{\text{sleeve,in}} = d_{\text{bar}} + 1 \text{ mm}, t_{\text{sleeve}} \geq 1,5 \text{ mm}$ $l_{\text{sleeve}} = 5 \cdot d_{\text{bar}} + \text{up to } 65 \text{ mm}$	Plastic PP, PE, PVC or stainless steel acc. to EN 1993-1-4 or normal steel; all $R_{p0,2} \geq 235 \text{ N/mm}^2$
DB-N	Bar	$d_{\text{bar}} = 20 \text{ mm}, 22 \text{ mm}, 24 \text{ mm}, 25 \text{ mm}, 27 \text{ mm}, 30 \text{ mm}, 35 \text{ mm}, 40 \text{ mm};$ $l_{\text{bar}} = 5 \cdot d_{\text{bar}} + \text{up to } 60 \text{ mm for joint widths } 10\text{-}60 \text{ mm and } l_{\text{bar}} = 5 \cdot d_{\text{bar}} + \text{up to } 120 \text{ mm for joint widths } 61\text{-}120 \text{ mm}$	Galvanized steel 1.7225, 1.7227 or stainless steel 1.4571, 1.4482, 1.4462, 1.4404, 1.4362, 1.4301 or normal steel; all $R_{p0,2} \geq 460 \text{ N/mm}^2$
	Anchor plate <sup>*1)</sup>	$w_{\text{APS}} = 65 \text{ mm up to } 200 \text{ mm}$ $h_{\text{APS}} = 85 \text{ mm up to } 210 \text{ mm}$ $t_{\text{APS}} = 4 \text{ mm up to } 10 \text{ mm}$	Stainless steel 1.4571, 1.4482, 1.4462, 1.4404, 1.4307, 1.4301 or normal steel; all $R_{p0,2} \geq 235 \text{ N/mm}^2$
	Ancillary reinforcement steel <sup>*2)</sup> (welded on the anchor plate)	$2 \times 1 \text{ U-bar: } \varnothing 10 \text{ mm}, \varnothing 12 \text{ mm}, \varnothing 14 \text{ mm}, \varnothing 16 \text{ mm or } \varnothing 20 \text{ mm}$ $l_{\text{U-bar}} \approx 0,3 \cdot \alpha_1 \cdot \alpha_4 \cdot l_{\text{b,rqd}} + 3 \varnothing_{\text{U-bar}}^{*4)}$ $h_{\text{U-bar}} \approx 5 \cdot d_{\text{bar}}$	B 500 A/B NR, B 500 A/B or B 550 A/B up to $\varnothing 20 \text{ mm};$ Stainless steel 1.4571, 1.4482, 1.4462, 1.4404, 1.4362, 1.4301 up to $\varnothing 20 \text{ mm};$ all $R_{p0,2} \geq 450 \text{ N/mm}^2$
	Supplementary reinforcement steel	$2 \times 1 \text{ up to } 2 \times 5 \text{ U-bars: } \varnothing 10 \text{ mm}, \varnothing 12 \text{ mm}, \varnothing 14 \text{ mm}, \varnothing 16 \text{ mm}, \varnothing 20 \text{ mm}, \varnothing 25 \text{ mm or } \varnothing 26 \text{ mm}$ $l_{\text{U-bar,supp}} \approx 0,6 \cdot \alpha_1 \cdot \alpha_4 \cdot l_{\text{b,rqd}} + 3 \varnothing_{\text{U-bar,supp}}^{*4)}$ $h_{\text{U-bar,supp}} = h_{\text{slab}} - c_{\text{v,upper}} - c_{\text{v,lower}}$	B 500 A/B or B 550 A/B
	Sleeve (circular)	$d_{\text{sleeve,in}} = d_{\text{bar}} + 1 \text{ mm}, t \geq 1,5 \text{ mm}$ $l_{\text{sleeve}} = 5 \cdot d_{\text{bar}} + \text{up to } 65 \text{ mm}$	Stainless steel acc. to EN 1993-1-4 or normal steel; all $R_{p0,2} \geq 235 \text{ N/mm}^2$
Strap	Steel strap <sup>*3)</sup>	dimensions can be chosen individually	Galvanized steel, stainless steel or normal steel; $R_{p0,2} \geq 235 \text{ N/mm}^2$
<p>*1) The height and width of the anchor plate can be increased slightly to meet the required thickness of concrete cover for the ancillary reinforcement steel.</p> <p>*2) A normal reinforcing steel B 500 A/B can be used, if the thickness of the concrete cover in accordance with EN 1992-1-1 is fulfilled, which can be controlled, for example, by the dimensions of the anchor plate.</p> <p>*3) The steel strap with its fixing to the dowel bar and the other rigid support has to be designed following the Eurocodes</p> <p>*4) The coefficient <math>\alpha_1</math> is set to 1.0 for straight legs of the supplementary reinforcement U-bars. The coefficient <math>\alpha_1</math> is set to 0.7 for standard bends, standard hooks or standard loops at the end of the supplementary reinforcement U-bars. The coefficient <math>\alpha_4</math> is usually set to 1.0. If there is a confinement by a transverse reinforcement bar with <math>\varnothing_t \geq 0.6 \cdot \varnothing_{\text{U-bar,supp}}</math> welded to each leg of the supplementary reinforcement U-bars, the coefficient <math>\alpha_4</math> can be set to 0.7. For the calculation of <math>l_{\text{b,rqd}}</math> the coefficient <math>\alpha_{ct}</math> is set to 1.0.</p>			
<b>StaLa Dowels – Components with Dimensions, Materials and Grades</b>			<b>Annex A7</b>
Product description			

## TreDo and StaLa with DB-N – Arrangement of Supplementary Reinforcement Steel

Designation of components

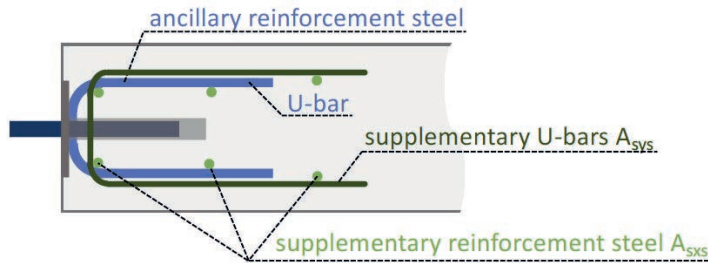

$$A_{sxs} \geq 2 \times 3 \cdot \varnothing A_{sys}$$

and  $A_{sys}$  acc. to Annex B5

Arrangement of supplementary reinforcement steel at small slab thicknesses

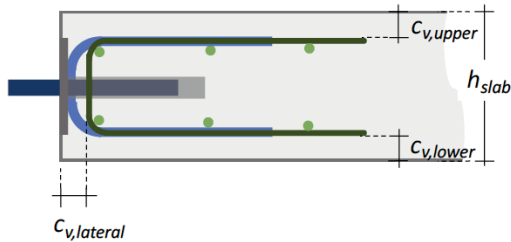

The minimum slab thickness is:

$$\min h_{slab} = h_{U-bar} + C_{v,upper} + C_{v,lower}$$

$$\geq \max (6 \cdot d_{bar} ; 150 \text{ mm})$$

with  $h_{U-bar}$  acc. to Annex B7

Arrangement of supplementary reinforcement steel at average slab thicknesses

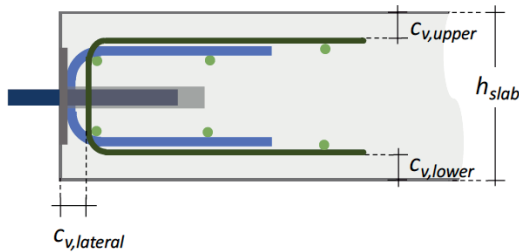

Arrangement of supplementary reinforcement steel at greater slab thicknesses

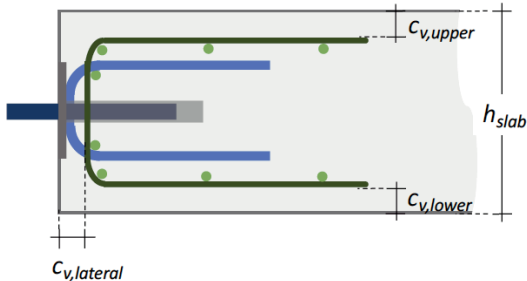

<p><b>TreDo and StaLa Dowels with DB-N – Arrangement of Reinforcement Steel</b></p>	<p><b>Annex A8</b></p>
<p>Product description</p>	



TreDo and StaLa with DB-N – Arrangement of Reinforcement Steel Bars

Designation of components

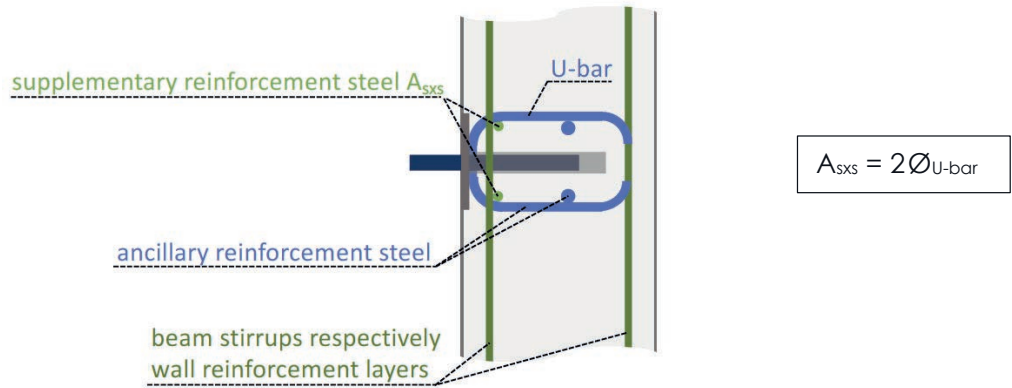

Arrangement of ancillary and supplementary reinforcement steel bars at beams

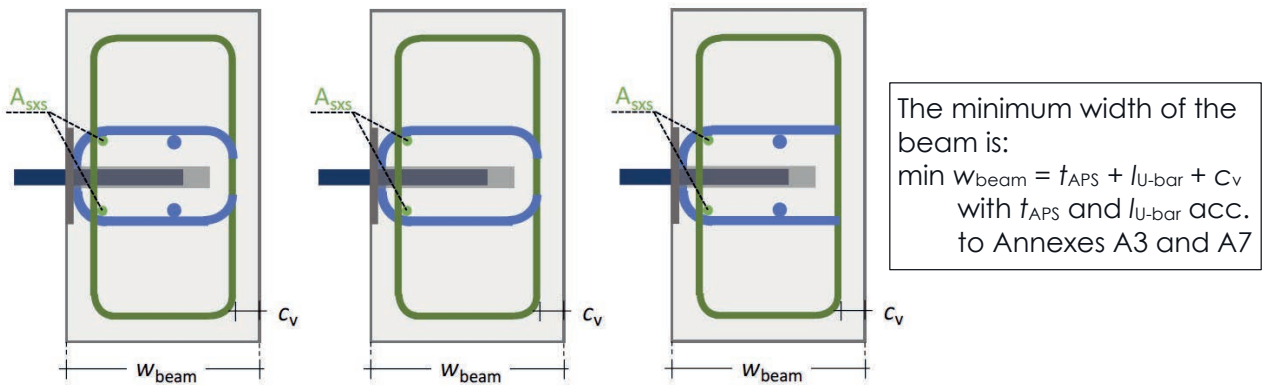

Arrangement of ancillary and supplementary reinforcement steel bars at walls

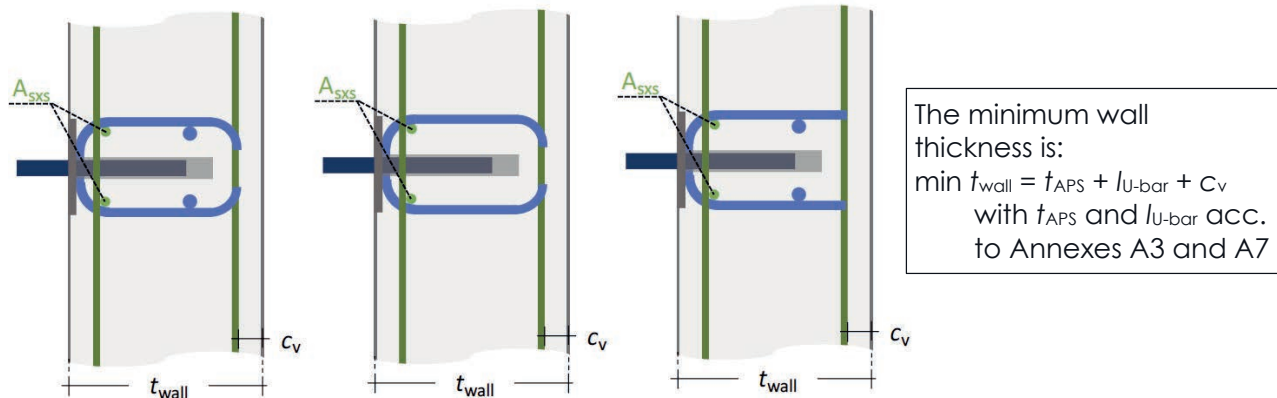

<p><b>TreDo and StaLa Dowels with DB-N – Arrangement of Reinforcement Steel</b></p>	
<p>Product description</p>	<p><b>Annex A9</b></p>

## Fire Protection Collars for TreDo and StaLa

Material and dimensions

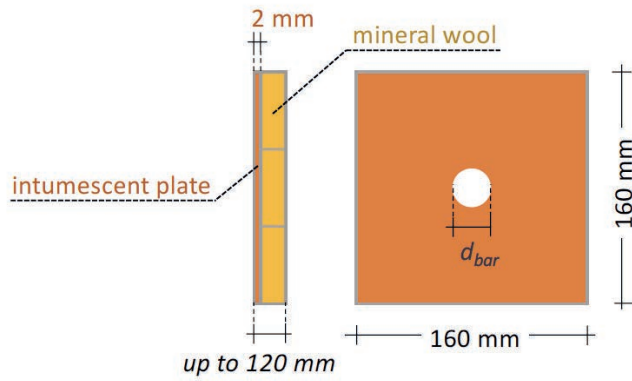

**Fire Protection Collars**

Product description

**Annex A10**

**TreDo with DB-N**

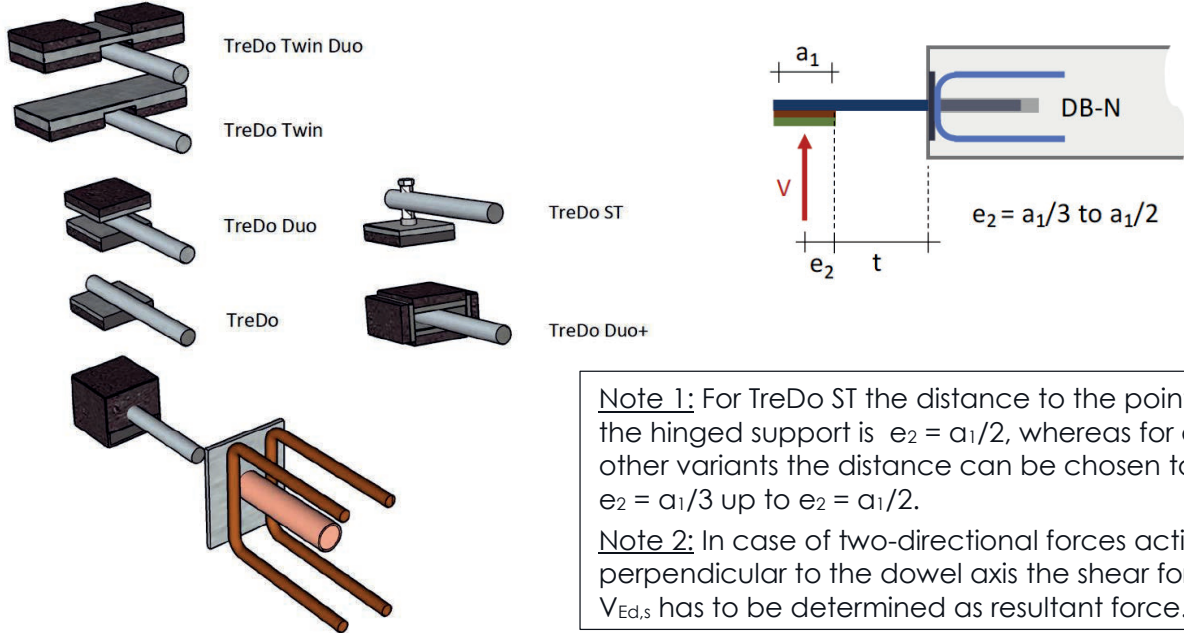

**Note 1:** For TreDo ST the distance to the point of the hinged support is  $e_2 = a_1/2$ , whereas for all other variants the distance can be chosen to  $e_2 = a_1/3$  up to  $e_2 = a_1/2$ .

**Note 2:** In case of two-directional forces acting perpendicular to the dowel axis the shear force  $V_{Ed,s}$  has to be determined as resultant force.

TreDo with DB-N, dowel bar  $R_{p0,2} = 750 \text{ N/mm}^2$

$V_{Rd,s,ULS}$ [kN]		joint width plus partial support width $t + e_2$ [mm]									
		30	40	50	60	70	80	90	100	110	120
$d_{bar}$ [mm]	$\varnothing 27$	67,1	50,3	40,3	33,6	28,8	25,2	22,4	20,1	18,3	16,8
	$\varnothing 30$	92,0	69,0	55,2	46,0	39,4	34,5	30,7	27,6	25,1	23,0
	$\varnothing 33$	122,5	91,9	73,5	61,3	52,5	45,9	40,8	36,8	33,4	30,6
	$\varnothing 35$	146,2	109,6	87,7	73,1	62,6	54,8	48,7	43,8	39,9	36,5
	$\varnothing 40$	218,2	163,6	130,9	109,1	93,5	81,8	72,7	65,5	59,5	54,5

TreDo with DB-N, dowel bar  $R_{p0,2} = 690 \text{ N/mm}^2$

$V_{Rd,s,ULS}$ [kN]		joint width plus partial support width $t + e_2$ [mm]									
		30	40	50	60	70	80	90	100	110	120
$d_{bar}$ [mm]	$\varnothing 27$	61,7	46,3	37,0	30,9	26,5	23,1	20,6	18,5	16,8	15,4
	$\varnothing 30$	84,7	63,5	50,8	42,3	36,3	31,8	28,2	25,4	23,1	21,2
	$\varnothing 33$	112,7	84,5	67,6	56,4	48,3	42,3	37,6	33,8	30,7	28,2
	$\varnothing 35$	134,5	100,9	80,7	67,2	57,6	50,4	44,8	40,3	36,7	33,6
	$\varnothing 40$	200,7	150,5	120,4	100,4	86,0	75,3	66,9	60,2	54,7	50,2

TreDo with DB-N, dowel bar  $R_{p0,2} = 460 \text{ N/mm}^2$

$V_{Rd,s,ULS}$ [kN]		joint width plus partial support width $t + e_2$ [mm]									
		30	40	50	60	70	80	90	100	110	120
$d_{bar}$ [mm]	$\varnothing 27$	41,2	30,9	24,7	20,6	17,6	15,4	13,7	12,3	11,2	10,3
	$\varnothing 30$	56,5	42,3	33,9	28,2	24,2	21,2	18,8	16,9	15,4	14,1
	$\varnothing 33$	75,1	56,4	45,1	37,6	32,2	28,2	25,0	22,5	20,5	18,8
	$\varnothing 35$	89,6	67,2	53,8	44,8	38,4	33,6	29,9	26,9	24,4	22,4
	$\varnothing 40$	133,8	100,4	80,3	66,9	57,4	50,2	44,6	40,1	36,5	33,5

**TreDo with DB-N – Resistances to Steel Failure**

Performances

**Annex B1**

## StaLa with DB-N

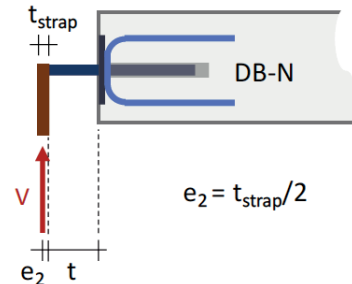
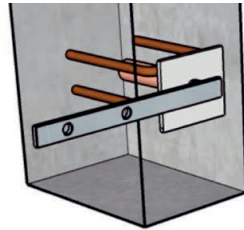

StaLa with DB-N, dowel bar  $R_{p0,2} = 750 \text{ N/mm}^2$

$V_{Rd,s,ULS}$ [kN]		joint width plus partial support width $t + e_2$ [mm]											
		10	20	30	40	50	60	70	80	90	100	110	120
$d_{bar}$ [mm]	$\varnothing 20$	73,4	40,9	27,3	20,5	16,4	13,6	11,7	10,2	9,1	8,2	7,4	6,8
	$\varnothing 22$	93,0	54,5	36,3	27,2	21,8	18,2	15,6	13,6	12,1	10,9	9,9	9,1
	$\varnothing 24$	114,9	70,7	47,1	35,3	28,3	23,6	20,2	17,7	15,7	14,1	12,9	11,8
	$\varnothing 25$	126,6	79,9	53,3	40,0	32,0	26,6	22,8	20,0	17,8	16,0	14,5	13,3
	$\varnothing 27$	151,7	100,7	67,1	50,3	40,3	33,6	28,8	25,2	22,4	20,1	18,3	16,8
	$\varnothing 30$	193,6	136,9	92,0	69,0	55,2	46,0	39,4	34,5	30,7	27,6	25,1	23,0
	$\varnothing 35$	274,6	208,4	146,2	109,6	87,7	73,1	62,6	54,8	48,7	43,8	39,9	36,5
	$\varnothing 40$	369,5	293,8	218,2	163,6	130,9	109,1	93,5	81,8	72,7	65,5	59,5	54,5

StaLa with DB-N, dowel bar  $R_{p0,2} = 690 \text{ N/mm}^2$

$V_{Rd,s,ULS}$ [kN]		joint width plus partial support width $t + e_2$ [mm]											
		10	20	30	40	50	60	70	80	90	100	110	120
$d_{bar}$ [mm]	$\varnothing 20$	67,6	37,6	25,1	18,8	15,1	12,5	10,8	9,4	8,4	7,5	6,8	6,3
	$\varnothing 22$	85,6	50,1	33,4	25,0	20,0	16,7	14,3	12,5	11,1	10,0	9,1	8,3
	$\varnothing 24$	105,7	65,0	43,4	32,5	26,0	21,7	18,6	16,3	14,5	13,0	11,8	10,8
	$\varnothing 25$	116,5	73,5	49,0	36,8	29,4	24,5	21,0	18,4	16,3	14,7	13,4	12,3
	$\varnothing 27$	139,6	92,6	61,7	46,3	37,0	30,9	26,5	23,1	20,6	18,5	16,8	15,4
	$\varnothing 30$	178,2	125,9	84,7	63,5	50,8	42,3	36,3	31,8	28,2	25,4	23,1	21,2
	$\varnothing 35$	252,6	191,7	134,5	100,9	80,7	67,2	57,6	50,4	44,8	40,3	36,7	33,6
	$\varnothing 40$	339,9	270,3	200,7	150,5	120,4	100,4	86,0	75,3	66,9	60,2	54,7	50,2

StaLa with DB-N, dowel bar  $R_{p0,2} = 460 \text{ N/mm}^2$

$V_{Rd,s,ULS}$ [kN]		joint width plus partial support width $t + e_2$ [mm]											
		10	20	30	40	50	60	70	80	90	100	110	120
$d_{bar}$ [mm]	$\varnothing 20$	45,0	25,1	16,7	12,5	10,0	8,4	7,2	6,3	5,6	5,0	4,6	4,2
	$\varnothing 22$	57,1	33,4	22,3	16,7	13,4	11,1	9,5	8,3	7,4	6,7	6,1	5,6
	$\varnothing 24$	70,4	43,4	28,9	21,7	17,3	14,5	12,4	10,8	9,6	8,7	7,9	7,2
	$\varnothing 25$	77,6	49,0	32,7	24,5	19,6	16,3	14,0	12,3	10,9	9,8	8,9	8,2
	$\varnothing 27$	93,1	61,7	41,2	30,9	24,7	20,6	17,6	15,4	13,7	12,3	11,2	10,3
	$\varnothing 30$	118,8	83,9	56,5	42,3	33,9	28,2	24,2	21,2	18,8	16,9	15,4	14,1
	$\varnothing 35$	168,4	127,8	89,6	67,2	53,8	44,8	38,4	33,6	29,9	26,9	24,4	22,4
	$\varnothing 40$	226,6	180,2	133,8	100,4	80,3	66,9	57,4	50,2	44,6	40,1	36,5	33,5

### StaLa with DB-N – Resistances to Steel Failure

Performances

Annex B2

**StLa with ESD-N**

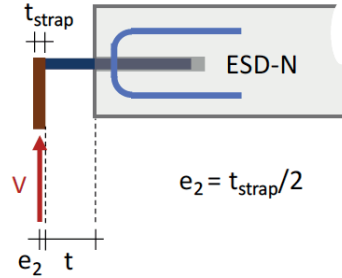
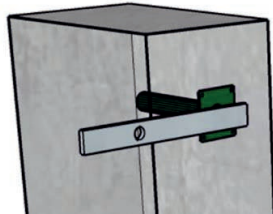
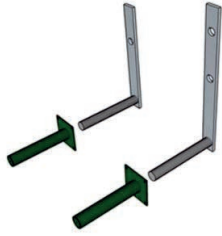

StLa with ESD-N, dowel bar  $R_{p0,2} = 750 \text{ N/mm}^2$

$V_{Rd,s,ULS}$ [kN]		joint width plus partial support width $t + e_2$ [mm]					
		10	20	30	40	50	60
$d_{bar}$ [mm]	$\emptyset 16$	23,3	15,0	11,0	8,7	7,2	6,2
	$\emptyset 20$	40,9	27,3	20,5	16,4	13,6	11,7
	$\emptyset 22$	51,9	35,1	26,6	21,4	17,9	15,3
	$\emptyset 24$	64,3	44,2	33,7	27,2	22,8	19,6
	$\emptyset 25$	71,0	49,2	37,6	30,4	25,6	22,0
	$\emptyset 27$	85,7	60,1	46,3	37,6	31,7	27,4
	$\emptyset 30$	110,5	78,9	61,4	50,2	42,5	36,8
	$\emptyset 35$	159,5	116,9	92,3	76,3	65,0	56,6

StLa with ESD-N, dowel bar  $R_{p0,2} = 690 \text{ N/mm}^2$

$V_{Rd,s,ULS}$ [kN]		joint width plus partial support width $t + e_2$ [mm]					
		10	20	30	40	50	60
$d_{bar}$ [mm]	$\emptyset 16$	21,4	13,8	10,1	8,0	6,6	5,7
	$\emptyset 20$	37,6	25,1	18,8	15,1	12,5	10,8
	$\emptyset 22$	47,7	32,3	24,4	19,6	16,4	14,1
	$\emptyset 24$	59,1	40,6	31,0	25,0	21,0	18,1
	$\emptyset 25$	65,3	45,2	34,6	28,0	23,5	20,3
	$\emptyset 27$	78,8	55,3	42,6	34,6	29,2	25,2
	$\emptyset 30$	101,6	72,6	56,5	46,2	39,1	33,9
	$\emptyset 35$	146,7	107,6	84,9	70,2	59,8	52,1

StLa with ESD-N, dowel bar  $R_{p0,2} = 460 \text{ N/mm}^2$

$V_{Rd,s,ULS}$ [kN]		joint width plus partial support width $t + e_2$ [mm]					
		10	20	30	40	50	60
$d_{bar}$ [mm]	$\emptyset 16$	14,3	9,2	6,8	5,4	4,4	3,8
	$\emptyset 20$	25,1	16,7	12,5	10,0	8,4	7,2
	$\emptyset 22$	31,8	21,5	16,3	13,1	10,9	9,4
	$\emptyset 24$	39,4	27,1	20,6	16,7	14,0	12,0
	$\emptyset 25$	43,6	30,2	23,1	18,7	15,7	13,5
	$\emptyset 27$	52,5	36,9	28,4	23,1	19,4	16,8
	$\emptyset 30$	67,7	48,4	37,6	30,8	26,1	22,6
	$\emptyset 35$	97,8	71,7	56,6	46,8	39,8	34,7

**StLa with ESD-N – Resistances to Steel Failure**

Performances

**Annex B3**

## StaLa with ESD-N (continued)

StaLa with ESD-N, dowel bar  $R_{p0,2} = 355 \text{ N/mm}^2$

$V_{Rd,s,ULS}$ [kN]		joint width plus partial support width $t + e_2$ [mm]					
		10	20	30	40	50	60
$d_{bar}$ [mm]	Ø 16	11,0	7,1	5,2	4,1	3,4	2,9
	Ø 20	19,4	12,9	9,7	7,7	6,5	5,5
	Ø 22	24,5	16,6	12,6	10,1	8,5	7,3
	Ø 24	30,4	20,9	15,9	12,9	10,8	9,3
	Ø 25	33,6	23,3	17,8	14,4	12,1	10,4
	Ø 27	40,5	28,4	21,9	17,8	15,0	13,0
	Ø 30	52,3	37,3	29,0	23,8	20,1	17,4
	Ø 35	75,5	55,3	43,7	36,1	30,7	26,8

StaLa with ESD-N, dowel bar  $R_{p0,2} = 275 \text{ N/mm}^2$

$V_{Rd,s,ULS}$ [kN]		joint width plus partial support width $t + e_2$ [mm]					
		10	20	30	40	50	60
$d_{bar}$ [mm]	Ø 16	8,5	5,5	4,0	3,2	2,6	2,3
	Ø 20	15,0	10,0	7,5	6,0	5,0	4,3
	Ø 22	19,0	12,9	9,7	7,8	6,5	5,6
	Ø 24	23,6	16,2	12,3	10,0	8,4	7,2
	Ø 25	26,0	18,0	13,8	11,2	9,4	8,1
	Ø 27	31,4	22,0	17,0	13,8	11,6	10,0
	Ø 30	40,5	28,9	22,5	18,4	15,6	13,5
	Ø 35	58,5	42,9	33,8	28,0	23,8	20,7

StaLa with ESD-N, dowel bar  $R_{p0,2} = 235 \text{ N/mm}^2$

$V_{Rd,s,ULS}$ [kN]		joint width plus partial support width $t + e_2$ [mm]					
		10	20	30	40	50	60
$d_{bar}$ [mm]	Ø 16	7,3	4,7	3,5	2,7	2,3	1,9
	Ø 20	12,8	8,5	6,4	5,1	4,3	3,7
	Ø 22	16,2	11,0	8,3	6,7	5,6	4,8
	Ø 24	20,1	13,8	10,5	8,5	7,1	6,2
	Ø 25	22,3	15,4	11,8	9,5	8,0	6,9
	Ø 27	26,8	18,8	14,5	11,8	9,9	8,6
	Ø 30	34,6	24,7	19,2	15,7	13,3	11,5
	Ø 35	50,0	36,6	28,9	23,9	20,4	17,7

## StaLa with ESD-N – Resistances to Steel Failure (continued)

Performances

Annex B4

### Resistances to Concrete Edge Failure

The characteristic resistance to concrete edge failure of the slab at ULS is calculated following EOTA TR065, chapter 2.4, whereas equation (5a) is supplemented by the statical reduction factor  $k_{stat}$ .

$$V_{Rk,ce,ULS} = V_{Rk,ce,1} + V_{Rk,ce,2}$$

$$V_{Rk,ce,1} = X_1 \cdot k_{stat} \cdot \sum \psi_i \cdot A_s \cdot f_{yk} \cdot \left( \frac{f_{ck}}{f_{ck,nom}} \right)^{k_1}$$

$$\psi_i = 1 - 0.2 \cdot \left( \frac{l_{c,i}}{c_1} \right) \quad ; \quad f_{ck,nom} = 20 \text{ N/mm}^2$$

$$V_{Rk,ce,2} = \pi \cdot d_s \cdot \sum l'_{1,i} \cdot 2.25 \cdot 0.7 \cdot 0.3 \cdot f_{ck}^{2/3}$$

$$l'_{1,i} = l_{1,i} - l_{1,min}$$

$$l_{1,min} = d_s + 0.5 \cdot d_b \quad \text{with} \quad d_b \geq 4 \cdot d_s$$

The characteristic resistance to concrete edge failure of the slab at SLS is calculated acc. to EOTA TR065, chapter 2.5.

$$V_{Rk,ce,SLS} = X_2 \cdot V_{Rk,ce,ULS}$$

In accordance with EOTA TR065 [2], chapters 2.2, 2.4 and 2.5 the design values of the resistances to concrete edge failure of the slab are:

$$V_{Rd,ce,ULS} = \frac{V_{Rk,ce,ULS}}{\gamma_{m,ce,ULS}}$$

$$\gamma_{m,ce,ULS} = 1.5 \quad \text{partial safety factor}$$

$$V_{Rd,ce,SLS} = \frac{V_{Rk,ce,SLS}}{\gamma_{m,ce,SLS}}$$

$$\gamma_{m,ce,SLS} = 1.0 \quad \text{partial safety factor}$$

<b>Resistances to Concrete Edge Failure – Design Equations</b>	<b>Annex B5</b>
Performances	

## Resistances to Concrete Edge Failure (continued)

Statical reduction factor  $k_{stat}$  for TreDo with DB-N and StaLa with DB-N

$k_{stat}$	joint width plus partial support width $t + e_2$ [mm]												
	dowel bar	10	20	30	40	50	60	70	80	90	100	110	120
Ø 20 mm	0,92	0,78	0,68	0,61	0,55	0,50	0,45	0,42	0,39	0,36	0,34	0,32	
Ø 30 mm	0,94	0,84	0,76	0,69	0,64	0,59	0,55	0,51	0,48	0,45	0,43	0,41	
Ø 40 mm	0,95	0,87	0,80	0,75	0,70	0,65	0,61	0,58	0,55	0,52	0,49	0,47	

Note 1: For intermediate dowel bar diameters a linear interpolation is possible.

Note 2: For TreDo with DB-N a sum of  $t + e_2$  from 30 mm to 120 mm is applicable and for StaLa with DB-N a sum of  $t + e_2$  from 10 mm to 120 mm is possible. For the definition of  $t + e_2$  see Annexes B1 to B4.

Alternatively the statical reduction factor  $k_{stat}$  for TreDo with DB-N and StaLa with DB-N can be calculated under consideration of  $t + e_2$  (see Annexes B1 to B4)

– for all dowel bar sizes from Ø 20 mm or greater to:

$$k_{stat} = -0,249 \cdot \ln(t + e_2) + 1,51$$

– for dowel bar sizes from Ø 30 mm or greater to:

$$k_{stat} = -0,225 \cdot \ln(t + e_2) + 1,50$$

with a sum of  $t + e_2$  from 30 mm to 120 mm for TreDo with DB-N and a sum of  $t + e_2$  from 10 mm to 120 mm for StaLa with DB-N

Statical reduction factor  $k_{stat}$  for StaLa with ESD-N

$k_{stat}$	joint width plus partial support width $t + e_2$ [mm]						
	dowel bar	10	20	30	40	50	60
Ø 16 mm	0,91	0,77	0,67	0,60	0,53	0,48	
Ø 25 mm	0,93	0,82	0,73	0,66	0,60	0,55	
Ø 35 mm	0,94	0,85	0,77	0,71	0,65	0,60	

Note 1: For intermediate dowel bar diameters a linear interpolation is possible.

Alternatively the statical reduction factor  $k_{stat}$  for StaLa with ESD-N can be calculated under consideration of  $t + e_2$  (see Annexes B1 to B4)

– for all dowel bar sizes from Ø 16 mm or greater to:

$$k_{stat,StaLa} = \frac{(t + e_2)^2}{10.000} - \frac{16 \cdot (t + e_2)}{1.000} + 1,06$$

– for dowel bar sizes from Ø 25 mm or greater to:

$$k_{stat,StaLa} = \frac{8 \cdot (t + e_2)^2}{100.000} - \frac{13 \cdot (t + e_2)}{1.000} + 1,05$$

with a sum of  $t + e_2$  from 10 mm to 60 mm for StaLa with ESD-N

<b>Resistances to Concrete Edge Failure (continued) – Statical Reduction Factor</b>	<b>Annex B6</b>
Performances	



### Resistances to Concrete Edge Failure (continued)

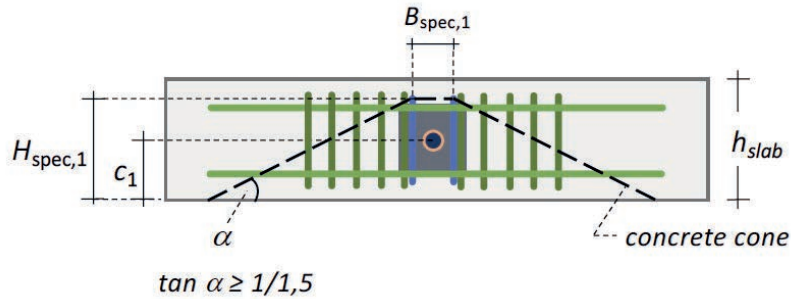

#### TreDo with DB-N – Design parameters

Dowel name	DB-N 27	DB-N 30	DB-N 33	DB-N 35	DB-N 40
$d_{bar}$ [mm]	27	30	33	35	40
U-bars [mm]	2 Ø12	2 Ø14	2 Ø16	2 Ø16	2 Ø20
$h_{U-bar}$ [mm]	140	140	160	170	210
$l_{c0s}$ [mm]	26,5	29,5	33	34,5	40
$B_{spec,1}$ [mm]	53	59	66	69	80
$H_{spec,1}$ [mm]	$c_1+64$	$c_1+68$	$c_1+72$	$c_1+77$	$c_1+95$

#### StaLa with DB-N – Design parameters

Dowel name	DB-N 20	DB-N 22	DB-N 24 DB-N 25	DB-N 27	DB-N 30	DB-N 35	DB-N 40
$d_{bar}$ [mm]	20	22	24/25	27	30	35	40
U-bars [mm]	2 Ø10	2 Ø10	2 Ø12	2 Ø12	2 Ø14	2 Ø16	2 Ø20
$h_{U-bar}$ [mm]	100	100	120	140	150	170	210
$l_{c0s}$ [mm]	21	22	25	26,5	29,5	34,5	40
$B_{spec,1}$ [mm]	42	44	50	53	59	69	80
$H_{spec,1}$ [mm]	$c_1+45$	$c_1+45$	$c_1+54$	$c_1+64$	$c_1+68$	$c_1+77$	$c_1+95$

For StaLa with ESD-N the design parameters are in general:

$$B_{spec,1} = 0$$

$$H_{spec,1} = c_1$$

### Resistances to Concrete Edge Failure (continued) – Design Parameters

Performances

Annex B7

## Performance characteristics with regard to load-bearing performance in case of fire

If the performance characteristics specified in Section 3 are complied with, the load-bearing capacity of the connection of reinforced concrete members with the shear force dowel in accordance with the intended use is also given under fire exposure according to the standard temperature curve for a duration of 120 minutes if the following conditions are met:

- Compliance with the design conditions in accordance with Annex A and the design requirements according to Annex B.
- Use and installation in accordance with Annex A and B.
- The design of the load-bearing capacity of the connection with the shear force dowel under normal temperatures was carried out in accordance with EOTA TR 065 and Annex B.
- For structural fire design (accidental fire situation), the action shall be determined on the basis of the normal temperature design of the load-bearing capacity, using a maximum reduction coefficient  $\eta_{fi}$  in accordance with EN 1992-1-2 or EN 1993-1-2 respectively, Section 2.4.2 of  $\eta_{fi} = 0,7$ .
- The load-bearing capacity of the reinforced concrete members under fire exposure shall be verified for the intended use.
- The required axis distances of the steel reinforcement bars in case of fire have to be considered in accordance with EN 1992-1-2. The resulting concrete covers  $c_v$  and the minimum slab thickness  $h_{slab}$  acc. to Annex A8 and the minimum beam widths  $w_{beam}$  or wall thicknesses  $t_{wall}$  acc. to Annex A9 have to be met.

<b>TreDo and StaLa Dowels – Performance Characteristics in Case of Fire</b>	
Resistance to fire	<b>Annex C1</b>

## NOTES

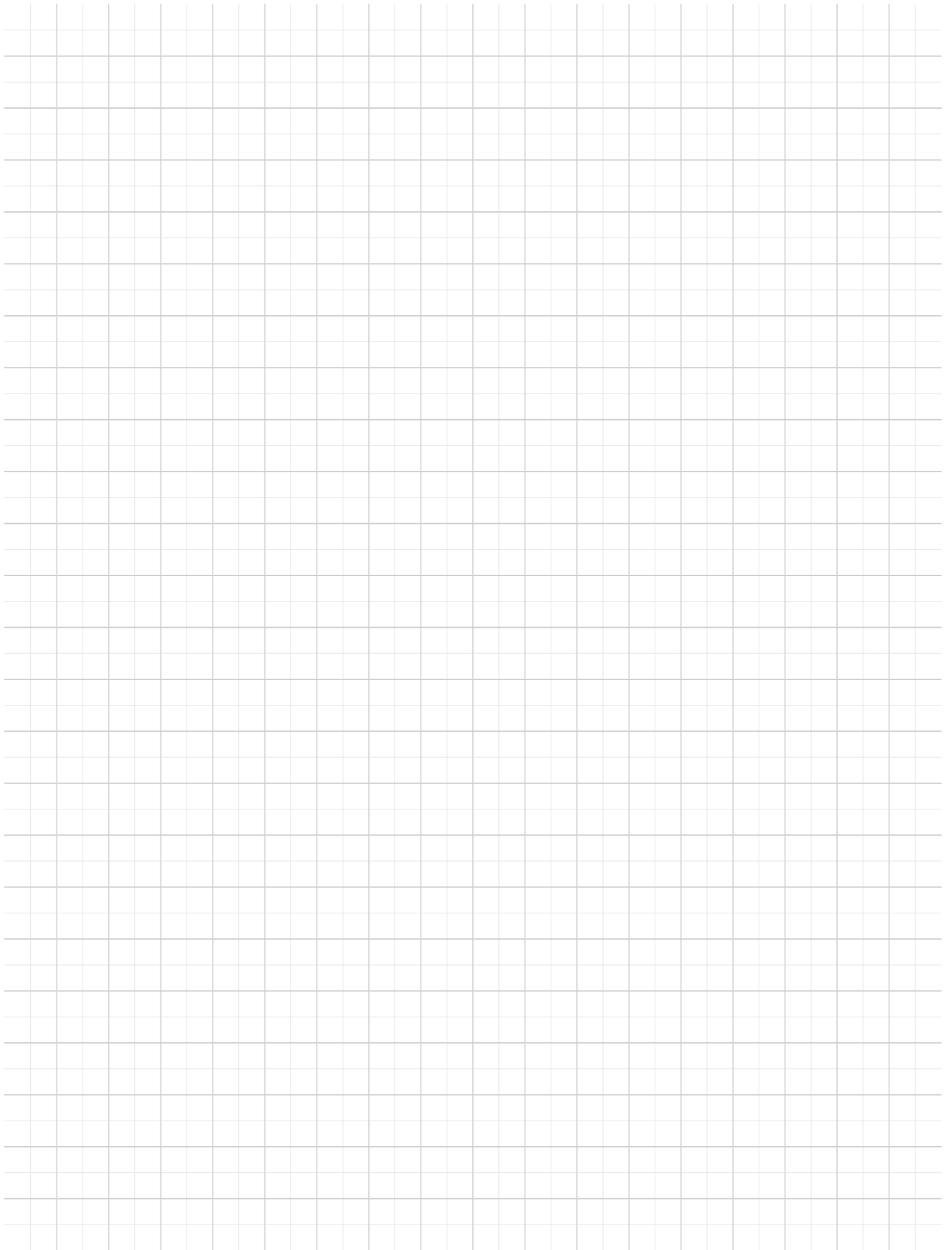



**PHILIPP GmbH**

Lilienthalstrasse 7-9  
63741 Aschaffenburg

☎ + 49 6021 40 27-0  
✉ info@philipp-gruppe.de

**PHILIPP GmbH**

Roßlauer Strasse 70  
06869 Coswig/Anhalt

☎ + 49 34903 6 94-0  
✉ info@philipp-gruppe.de

**PHILIPP GmbH**

Sperberweg 37  
41468 Neuss

☎ + 49 2131 3 59 18-0  
✉ info@philipp-gruppe.de

**PHILIPP ACON Hydraulik GmbH**

Hinter dem grünen Jäger 3  
38836 Dardesheim

☎ + 49 39422 95 68-0  
✉ info@philipp-gruppe.de



**PHILIPP Vertriebs GmbH**

Leogangerstraße 21  
5760 Saalfelden / Salzburg

☎ + 43 6582 7 04 01  
✉ info@philipp-gruppe.at



Visit us!

[www.philipp-gruppe.de](http://www.philipp-gruppe.de)